



Yuasa Technical Data Sheet

Yuasa M26-EFB - Marine Batteries

Performance

Voltage	12V
Capacity (20-hour)	80Ah
Cold Cranking Amps (EN1)	600A

Dimensions

Length	260mm
Width	174mm
Height	225mm

Weights & Measures

Mean Weight with Acid	19.7kg
-----------------------	--------



Container Features

Case Type	GR24 BCI
Cell Layout	1
Hold Down	B5
State of Charge Indicator	✓
Handles	✓
End Venting	✓
Semi-Traction Features	✓
Lid Lid	SMF Double Lid

Technology

Flame Arrestor	✓
Technology	Ca/Ca
Separator	PE
Recommended Charge Rate	6A

Terminal Type

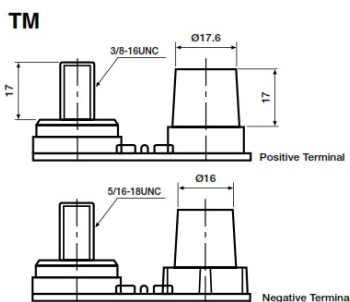

Cell Assembly Layout

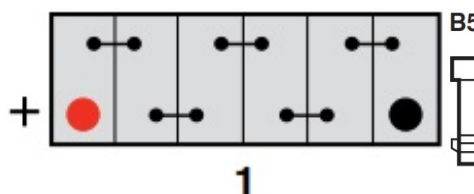

Battery Hold-down

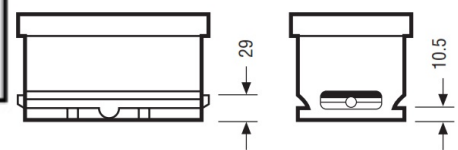

Data Sheet generated on 14/04/2021 - E&OE